

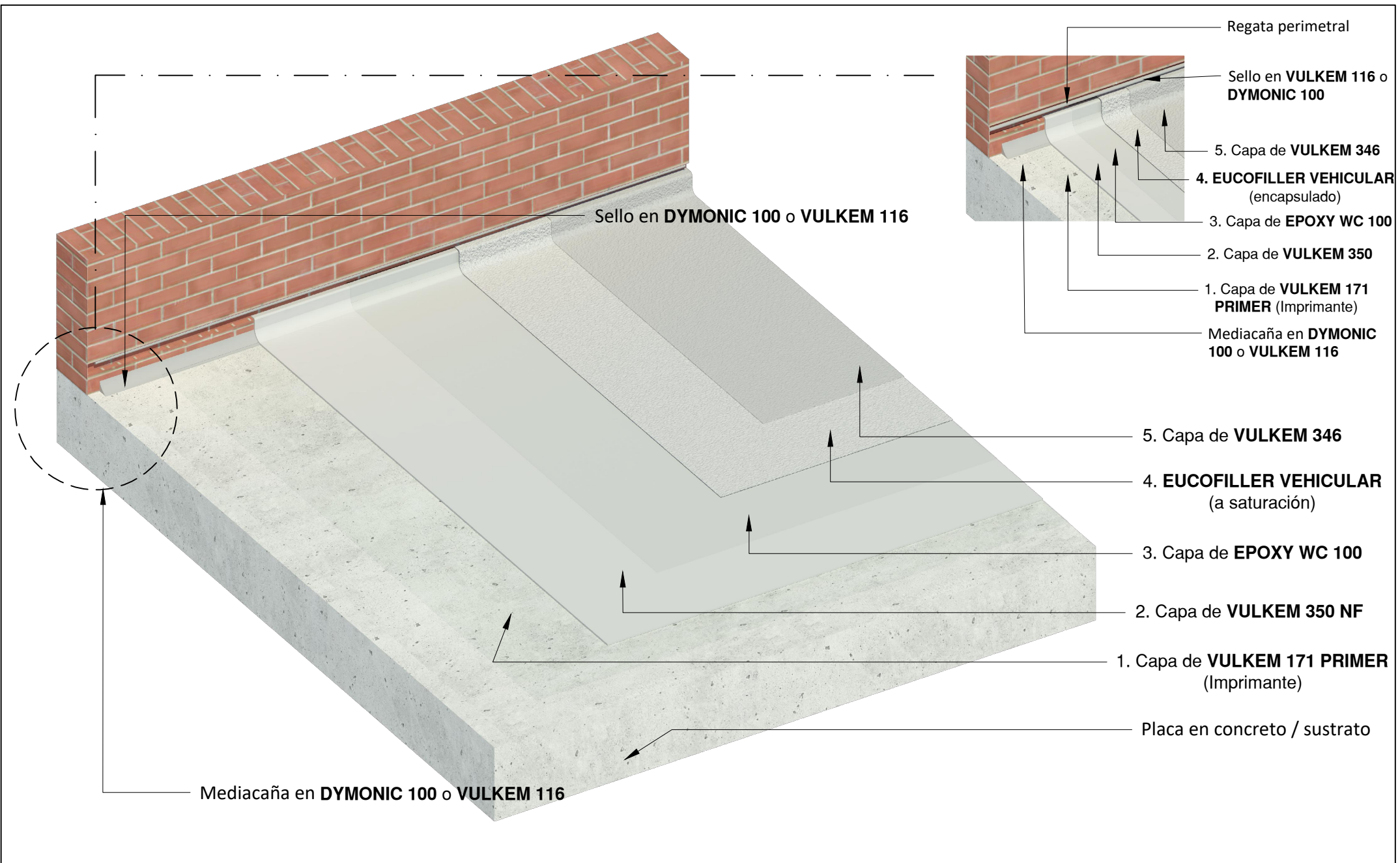

EUCLID CHEMICAL
TOXEMENT

Detalle D1	Contiene DETALLE DE INSTALACIÓN TÍPICO	Sistema VULKEM VEHICULAR (350NF/EPOXY WC 100/346)	Línea IMPERMEABILIZACIÓN DE PLACAS PARQUEADEROS	Fecha 24/01/2025	Versión V_01
Convenciones					Escala Sin escala





**EUCLID CHEMICAL
TOXEMENT**

Detalle D2	Contiene IMPERMEABILIZACIÓN DE PLACAS Y CUBIERTAS TRATAMIENTO DE FISURAS	Sistema VULKEM VEHICULAR (350NF/EPOXY WC 100/346)	Línea IMPERMEABILIZACIÓN DE PLACAS PARQUEADEROS	Fecha 24/01/2025	Versión V_01
Convenciones					Escala Sin escala

TRATAMIENTO DE FISURAS MENORES A 1.6 MM

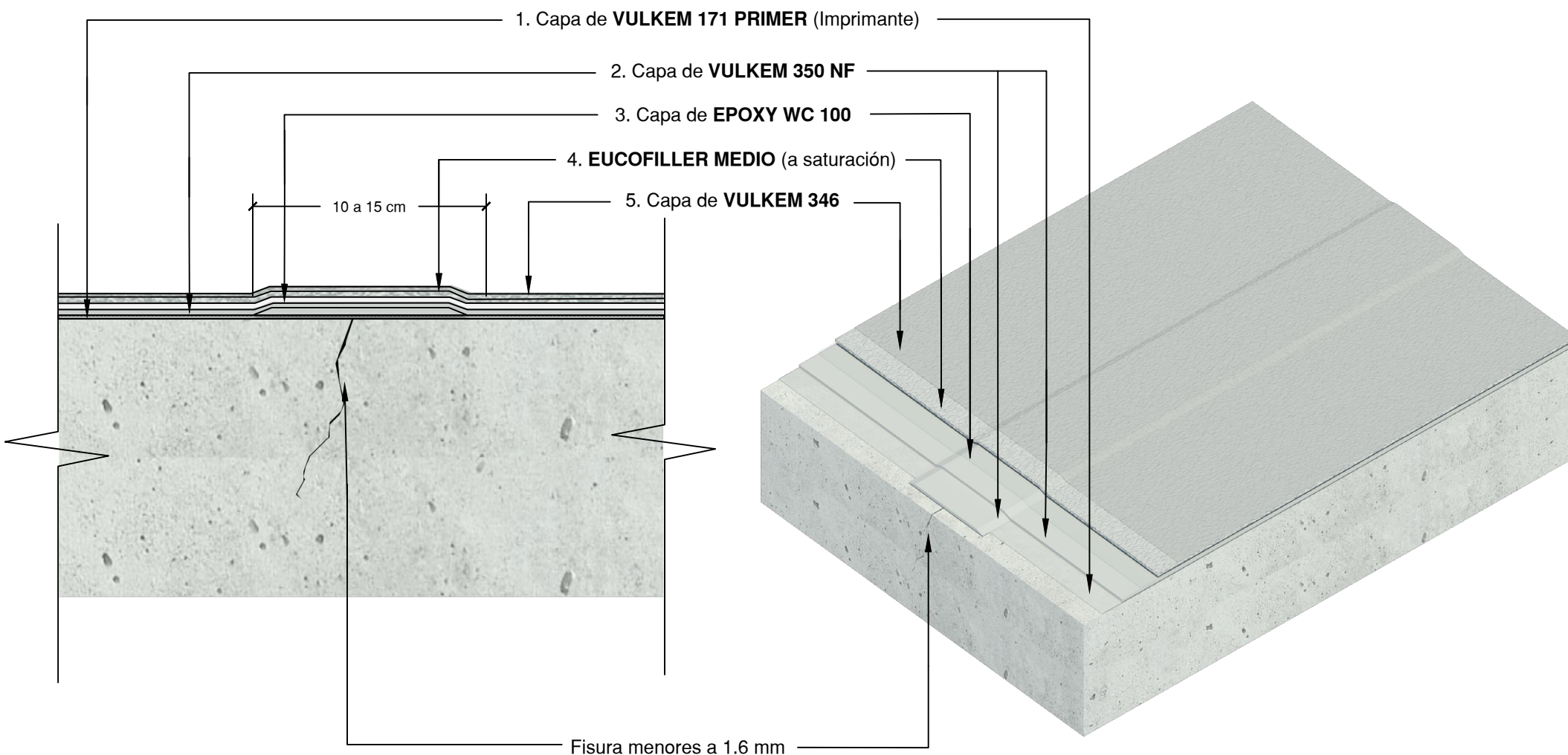

Nota: El Sistema **VULKEM VEHICULAR** cuenta con dos configuraciones SISTEMA ESTÁNDAR TRÁFICO MODERADO y SISTEMA HEAVY DUTY TRÁFICO PESADO. Revisar rendimientos y sugerencias técnicas de cada configuración en su correspondiente ficha técnica y/o guía de especificación.



EUCLID CHEMICAL
TOXEMENT

Detalle
D3

Contiene
IMPERMEABILIZACIÓN DE PLACAS
TRATAMIENTO EN CAMBIOS DE NIVEL

Sistema
VULKEM VEHICULAR (350NF/EPOXY WC 100/346)

Línea
IMPERMEABILIZACIÓN DE PLACAS PARQUEADEROS

Fecha
21/02/2025

Convenciones



EUCOFILLER MEDIO



VULKEM 351



VULKEM 350



EPOXY WC 100



VULKEM 171 PRIMER



DYMONIC 100/VULKEM 116



CONCRETO



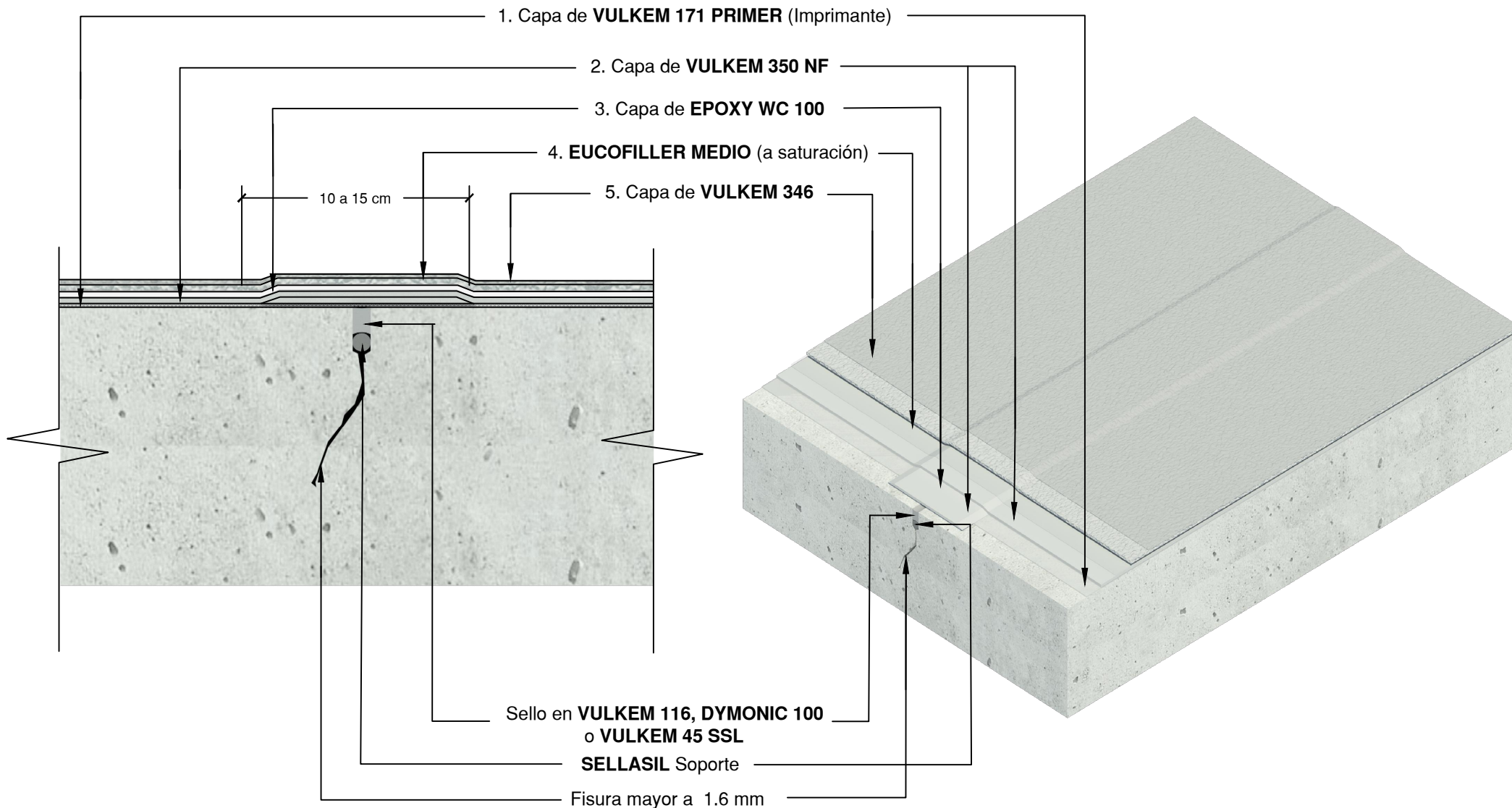



TRATAMIENTO DE FISURAS MAYORES A 1.6 MM



Nota: El Sistema **VULKEM VEHICULAR** cuenta con dos configuraciones SISTEMA ESTÁNDAR TRÁFICO MODERADO y SISTEMA HEAVY DUTY TRÁFICO PESADO. Revisar rendimientos y sugerencias técnicas de cada configuración en su correspondiente ficha técnica y/o guía de especificación.



EUCLID GROUP
TOXEMENT

Detalle	Contiene VULKEM VEHICULAR (350NF/EPOXY WC 100/346) TRATAMIENTO DE FISURAS	Sistema IMPERMEABILIZACIONES BASE POLIURETANO	Línea IMPERMEABILIZACIÓN DE PLACAS PARQUEADEROS	Fecha 18/02/25	Versión V_04		
Convenciones	 VULKEM 350	 VULKEM 346	 EUCOFILLER VEHICULAR	 VULKEM 171 PRIMER	 DYMONIC 100/ VULKEM 116	 Estructura en concreto	Escala Sin escala

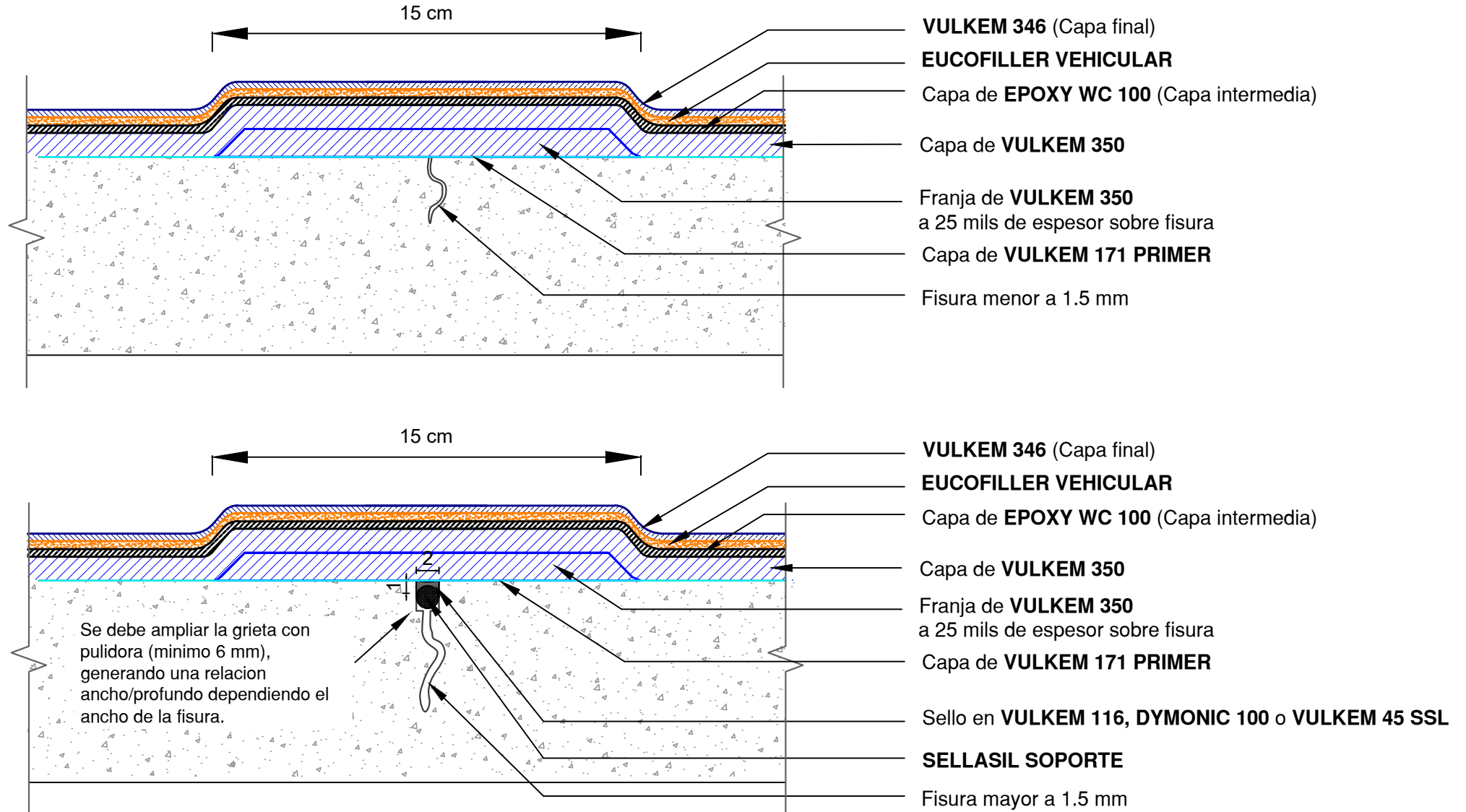



**EUCLID CHEMICAL
TOXEMENT**

Detalle
D4

Contiene
IMPERMEABILIZACIÓN DE PLACAS
TRATAMIENTO EN CAMBIOS DE NIVEL

Sistema
VULKEM VEHICULAR (350NF/EPOXY WC 100/346)

Línea
IMPERMEABILIZACIÓN DE PLACAS PARQUEADEROS

Fecha
21/02/2025

Versión
V_01

Convenciones



EUCOFILLER MEDIO



VULKEM 351



VULKEM 350



EPOXY WC 100



VULKEM 171 PRIMER



DYMONIC 100/VULKEM 116



CONCRETO



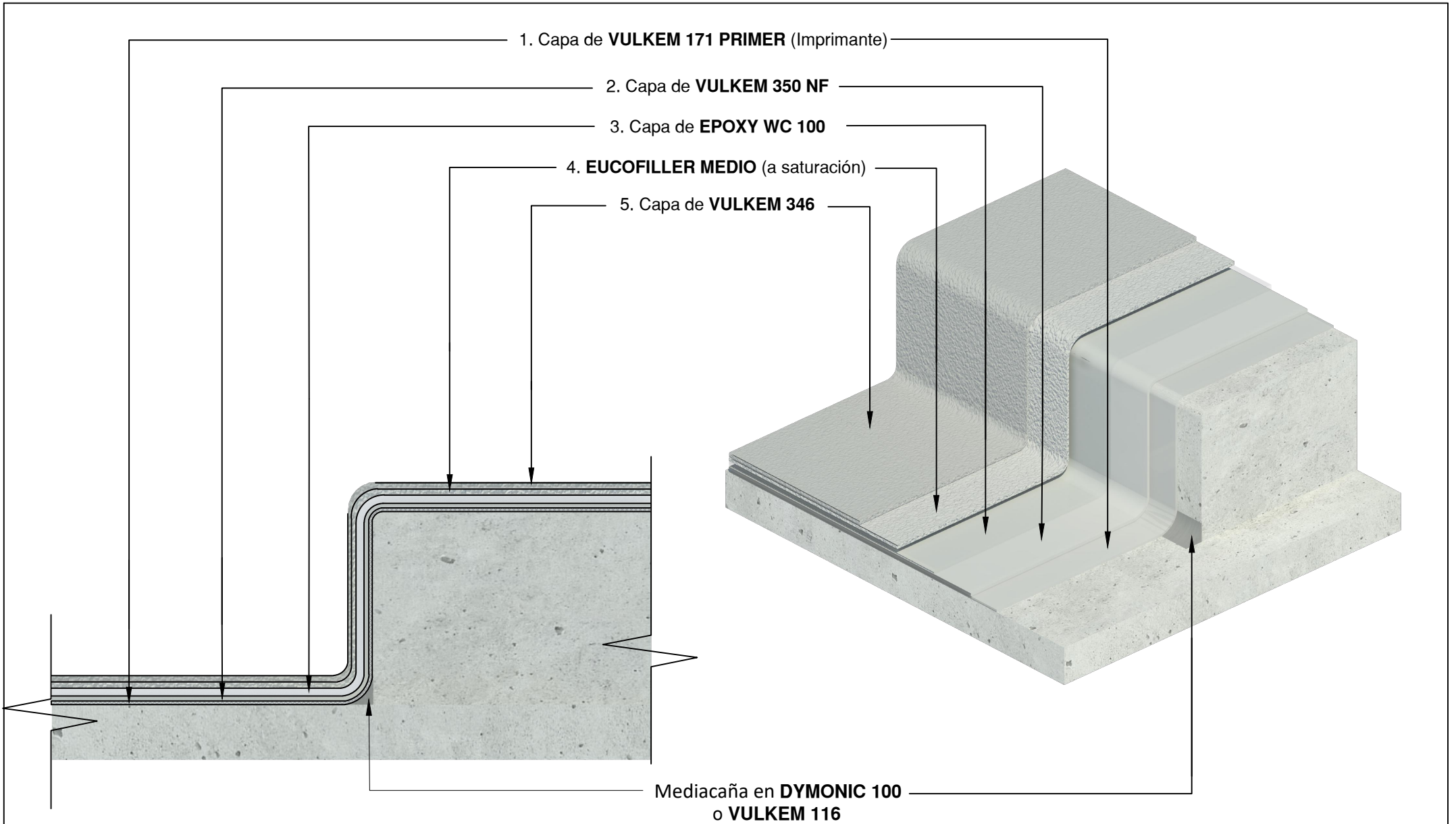

Escala
Sin escala



Nota: El Sistema **VULKEM VEHICULAR** cuenta con dos configuraciones SISTEMA ESTÁNDAR TRÁFICO MODERADO y SISTEMA HEAVY DUTY TRÁFICO PESADO. Revisar rendimientos y sugerencias técnicas de cada configuración en su correspondiente ficha técnica y/o guía de especificación.



EUCLID CHEMICAL
TOXEMENT

Detalle D8	Contiene TRATAMIENTO DE SIFONES Y DESAGÜES 1	Sistema VULKEM VEHICULAR (350NF/EPOXY WC 100/346)	Línea IMPERMEABILIZACIÓN DE PLACAS PARQUEADEROS	Fecha 09/11/2024	Versión V_03
Convenciones  SISTEMA VULKEM VEHICULAR  VULKEM 171 PRIMER  DYMONIC 100/ VULKEM 116  SELLASIL SOPORTE  Estructura en concreto					Escala Sin escala

Sello **VULKEM 116, DYMONIC 100**

Sistema **VULKEM VEHICULAR**

Imprimante
VULKEM 171 PRIMER

Cordón de polietileno
SELLASIL SOPORTE

TRATAMIENTO DE SIFONES Y DESAGÜES

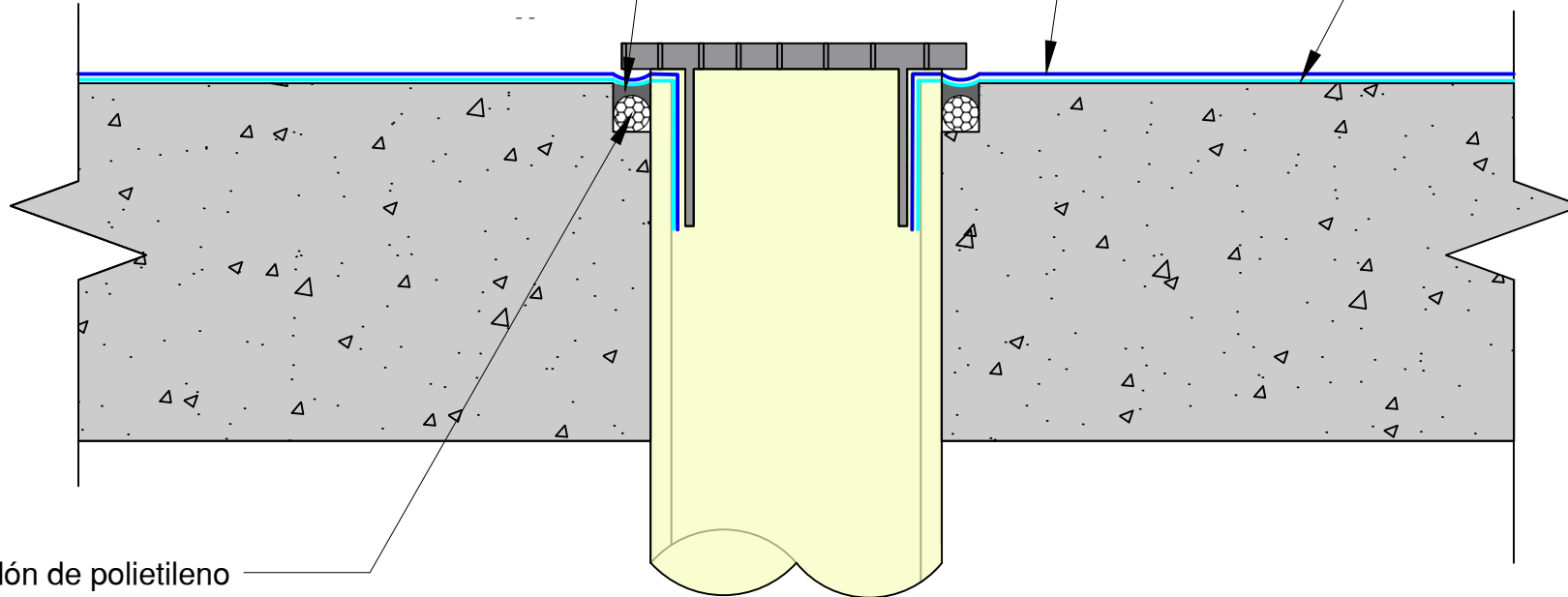



EUCLID CHEMICAL
TOXEMENT

Detalle

D1

Contiene

DETALLE DE TRATAMIENTO DE POSTES METÁLICOS

Sistema

VULKEM VEHICULAR

Línea

IMPERMEABILIZACIÓN DE PLACAS PARQUEADEROS

Fecha

21/02/25

Versión

V_01

Convenciones



VULKEM 350



VULKEM 346



EUCOFILLER VEHICULAR



DYMONIC 100/VULKEM 116



VULKEM 346

Escala

Sin escala

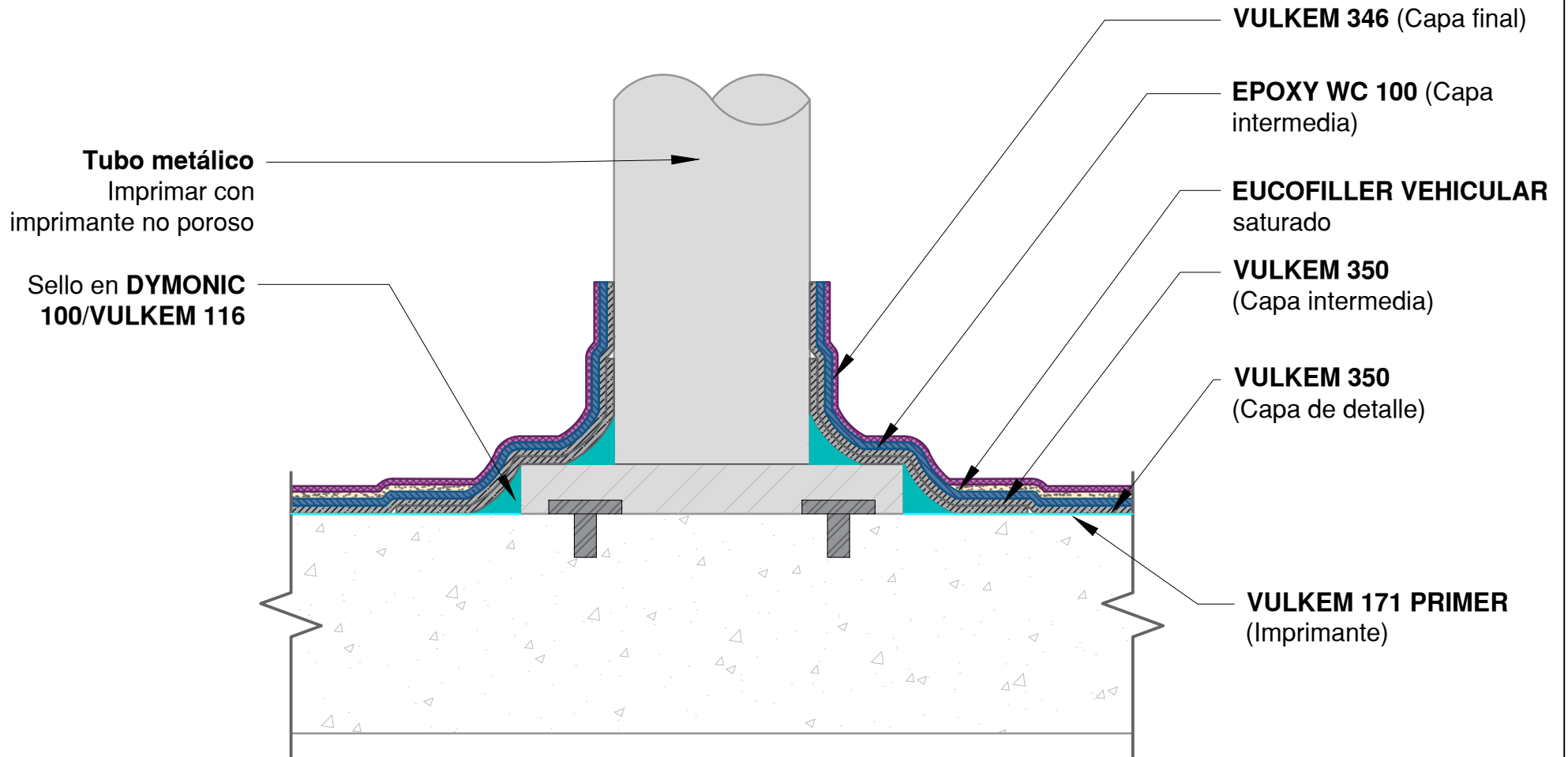



EUCAL CHEMICAL
TOXEMENT

Detalle D1	Contiene DETALLE DE TRATAMIENTO DE TOPELLANTAS	Sistema VULKEM VEHICULAR	Línea IMPERMEABILIZACIÓN DE PLACAS PARQUEADEROS	Fecha 21/02/25	Versión V_01
Convenciones					Escala Sin escala



VULKEM 350



VULKEM 346



EUCOFILLER VEHICULAR



DYMONIC 100/VULKEM 116



PEGANTE EPÓXICO

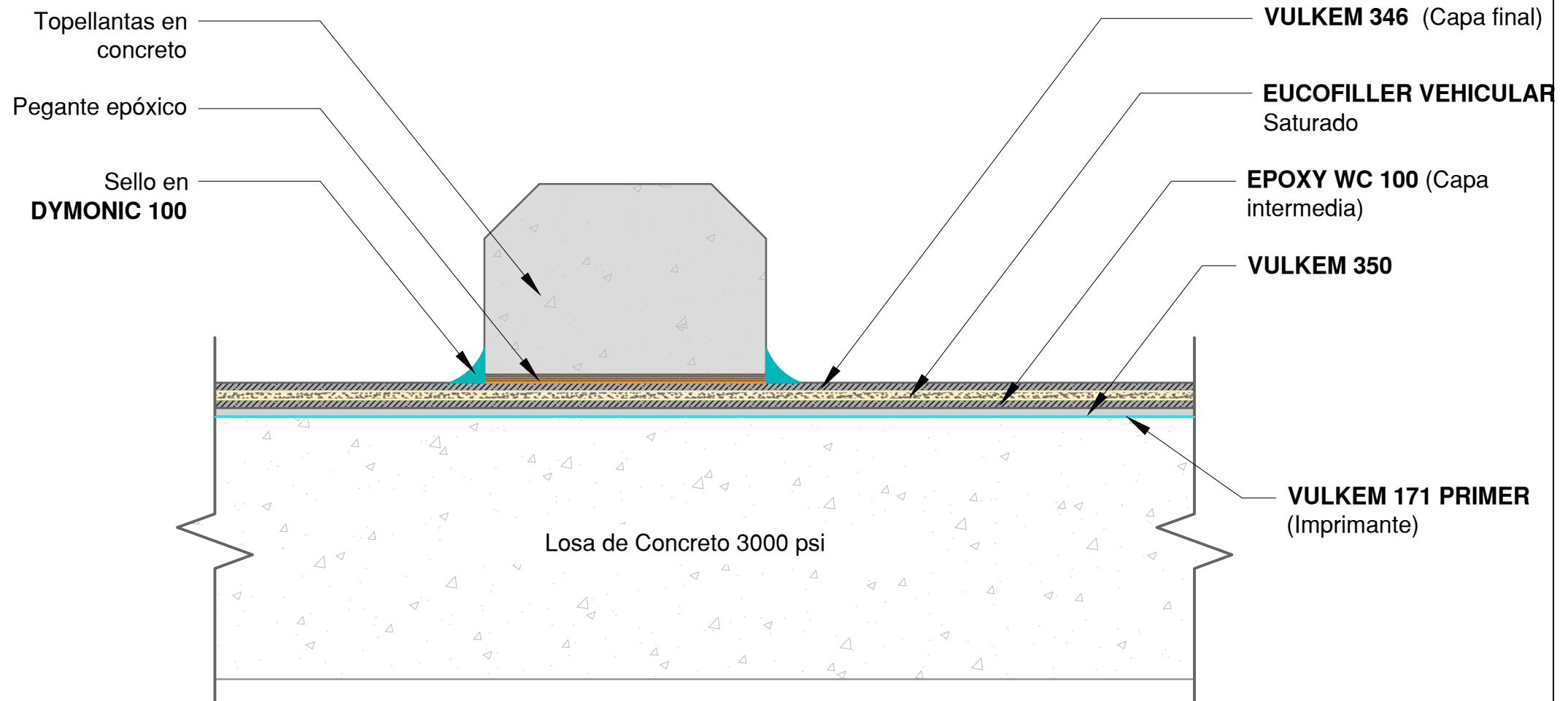



EUCLID GROUP
TOXEMENT

Detalle	Contiene VULKEM VEHICULAR (350NF/EPOXY WC 100/346) TRATAMIENTO DE FISURAS	Sistema IMPERMEABILIZACIONES BASE POLIURETANO	Línea IMPERMEABILIZACIÓN DE PLACAS PARQUEADEROS	Fecha 18/02/25	Versión V_04		
Convenciones	VULKEM 350	VULKEM 346	EUCOFILLER VEHICULAR	VULKEM 171 PRIMER	DYMONIC 100/ VULKEM 116	ESTRUCTURA EN CONCRETO	Escala Sin escala

