

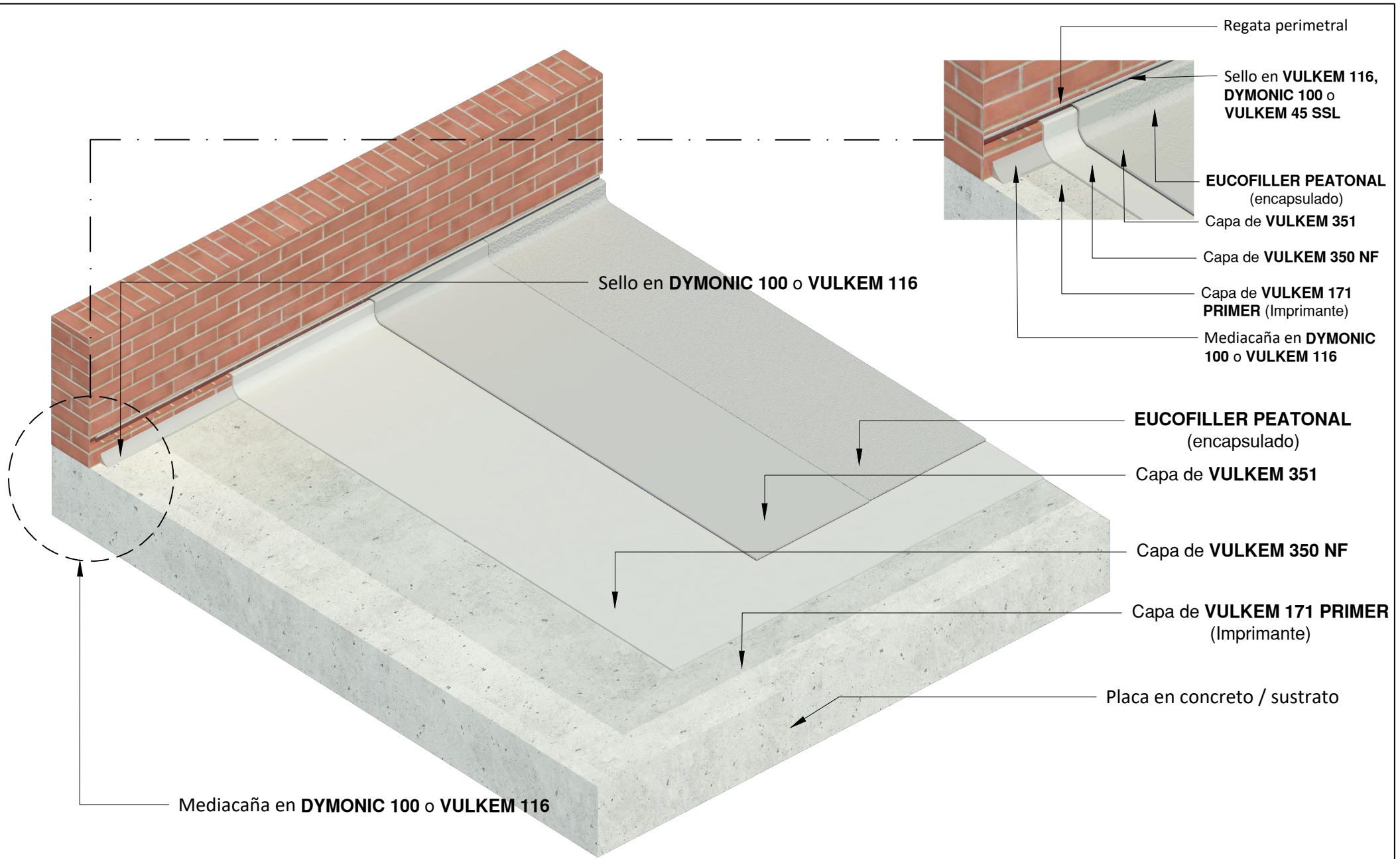

**EUCLID CHEMICAL  
TOXEMENT**

Detalle D1	Contiene DETALLE DE INSTALACIÓN TÍPICO	Sistema VULKEM PEATONAL (350NF/351) Y ESPORÁDICO	Línea IMPERMEABILIZACIÓN DE PLACAS Y CUBIERTAS	Fecha 09/11/2024	Versión V_01
Convenciones					Escala Sin escala

- Eucofiller Peatonal
- Vulkem 351
- Vulkem 350 NF
- Vulkem 171 Primer
- Dymonic 100/Vulkem 116
- Estructura en concreto





**EUCLID CHEMICAL  
TOXEMENT**

Detalle D2	Contiene IMPERMEABILIZACIÓN DE PLACAS Y CUBIERTAS TRATAMIENTO DE FISURAS	Sistema VULKEM PEATONAL (350NF/351) Y ESPORÁDICO	Línea IMPERMEABILIZACIÓN DE PLACAS Y CUBIERTAS	Fecha 09/11/2024	Versión V_01		
Convenciones	Eucofiller Peatonal	Vulkem 351	Vulkem 350 NF	Vulkem 171 Primer	Dymonic 100/Vulkem 116	Estructura en concreto	Escala Sin escala

### TRATAMIENTO DE FISURAS MENORES A 1.6 MM

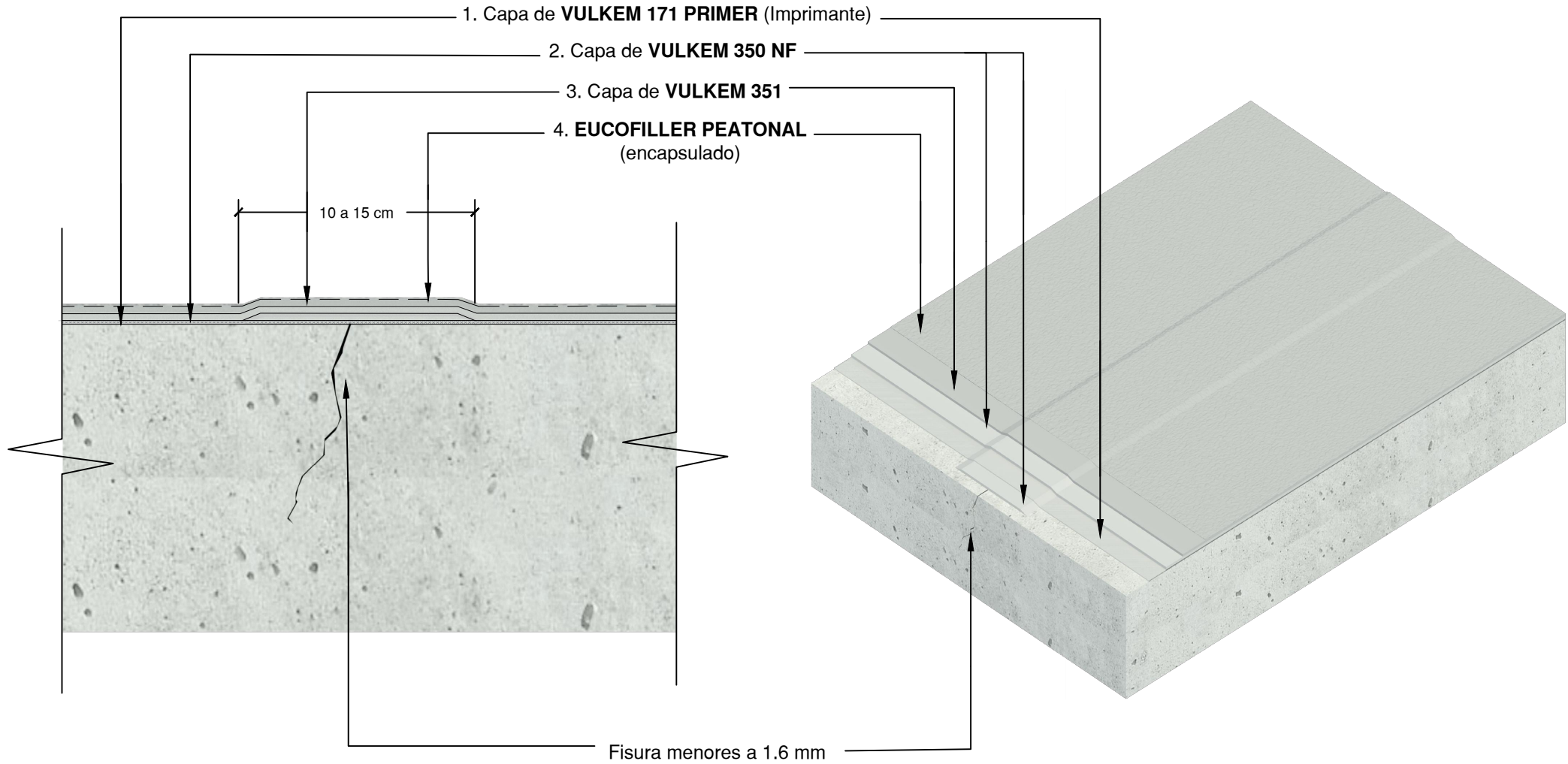

**Nota:** El Sistema **VULKEM PEATONAL** cuenta con diferentes configuraciones de acuerdo a las necesidades y requerimientos de la zona a impermeabilizar. Revisar rendimientos y sugerencias técnicas de cada configuración en su correspondiente ficha técnica y/o guía de especificación.



**EUCLID CHEMICAL  
TOXEMENT**

Detalle D3	Contiene IMPERMEABILIZACIÓN DE PLACAS Y CUBIERTAS TRATAMIENTO DE FISURAS	Sistema VULKEM PEATONAL (350NF/351) Y ESPORÁDICO	Línea IMPERMEABILIZACIÓN DE PLACAS Y CUBIERTAS	Fecha 09/11/2024	Versión V_02		
Convenciones	Eucofiller Peatonal	Vulkem 351	Vulkem 350 NF	Vulkem 171 Primer	Dymonic 100/Vulkem 116	Estructura en concreto	Escala Sin escala

### TRATAMIENTO DE FISURAS MAYORES A 1.6 MM

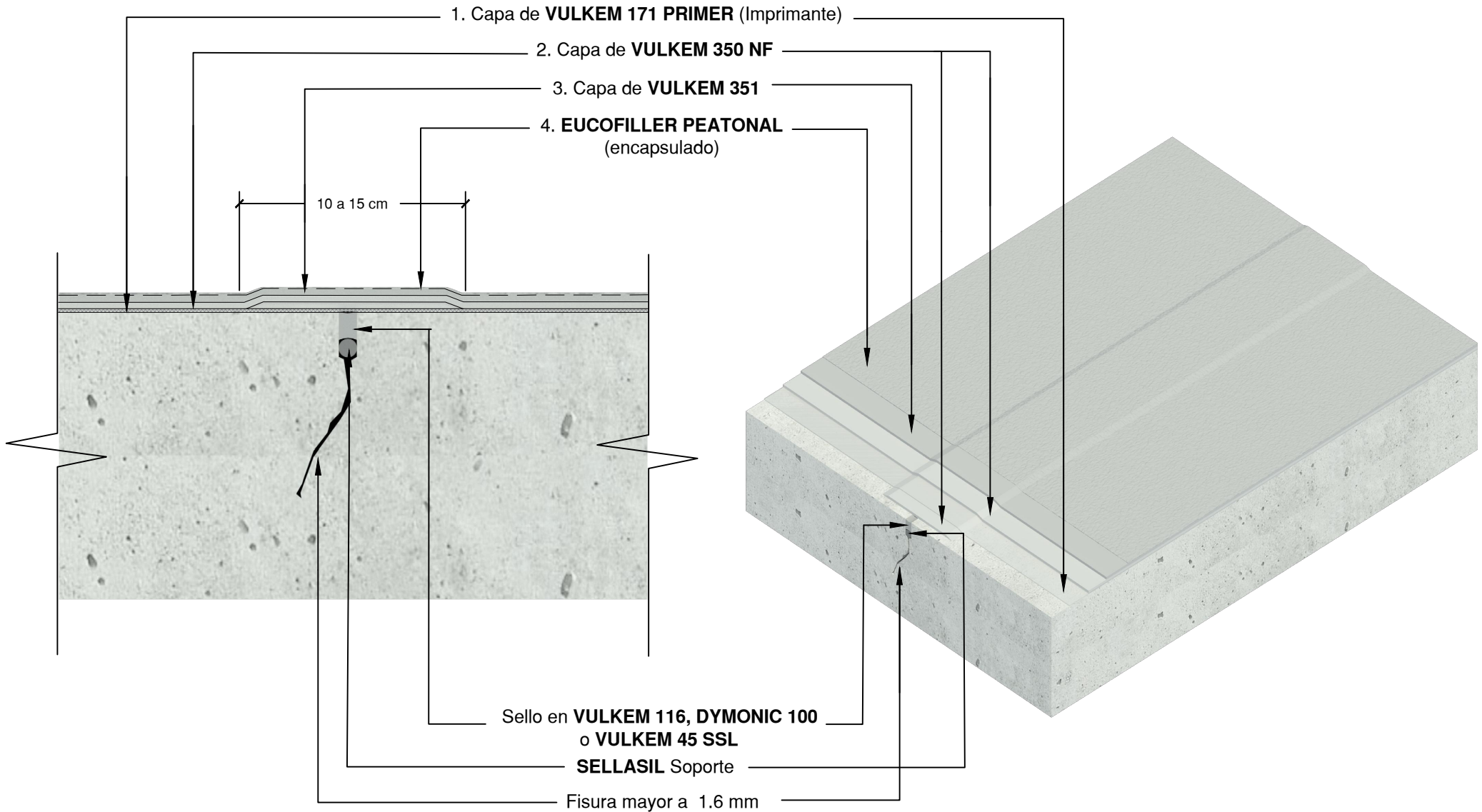

**Nota:** El Sistema **VULKEM PEATONAL** cuenta con diferentes configuraciones de acuerdo a las necesidades y requerimientos de la zona a impermeabilizar. Revisar rendimientos y sugerencias técnicas de cada configuración en su correspondiente ficha técnica y/o guía de especificación.



**EUCLID GROUP  
TOXEMENT**

Detalle D2/VP_Imp.PU	Contiene VULKEM PEATONAL (350NF/351) Y ESPORÁDICO TRATAMIENTO DE FISURAS	Sistema IMPERMEABILIZACIONES BASE POLIURETANO	Línea IMPERMEABILIZACIÓN DE PLACAS Y CUBIERTAS	Fecha 09/05/22	Versión V_04
Convenciones  Vulkem 350 NF SL  Vulkem 351  Eucofiller peatonal  Vulkem 171 Primer  Dymonic 100/Vulkem 116  Estructura en concreto					Escala Sin escala

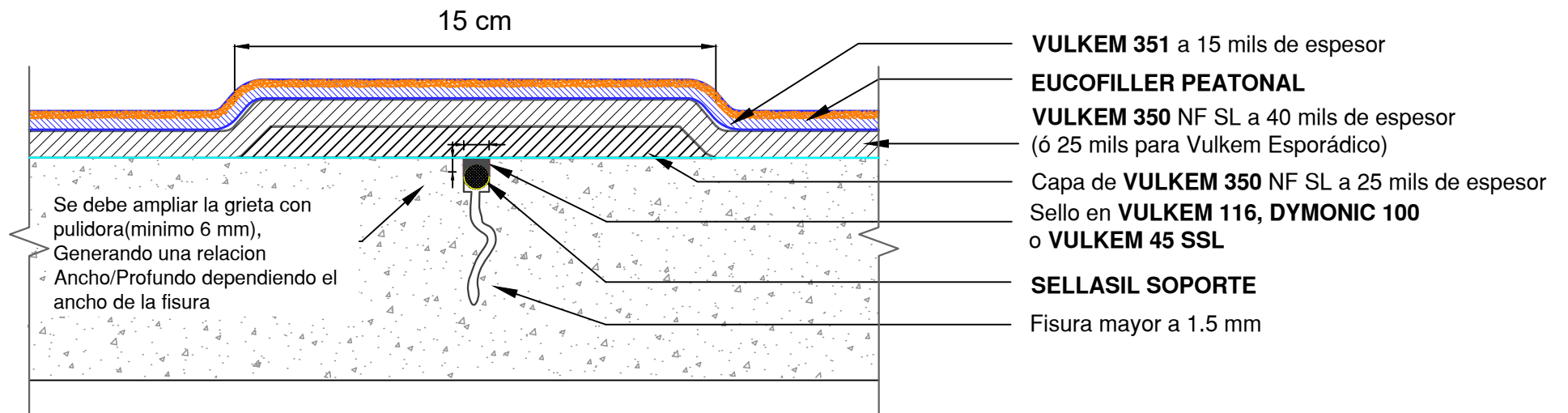
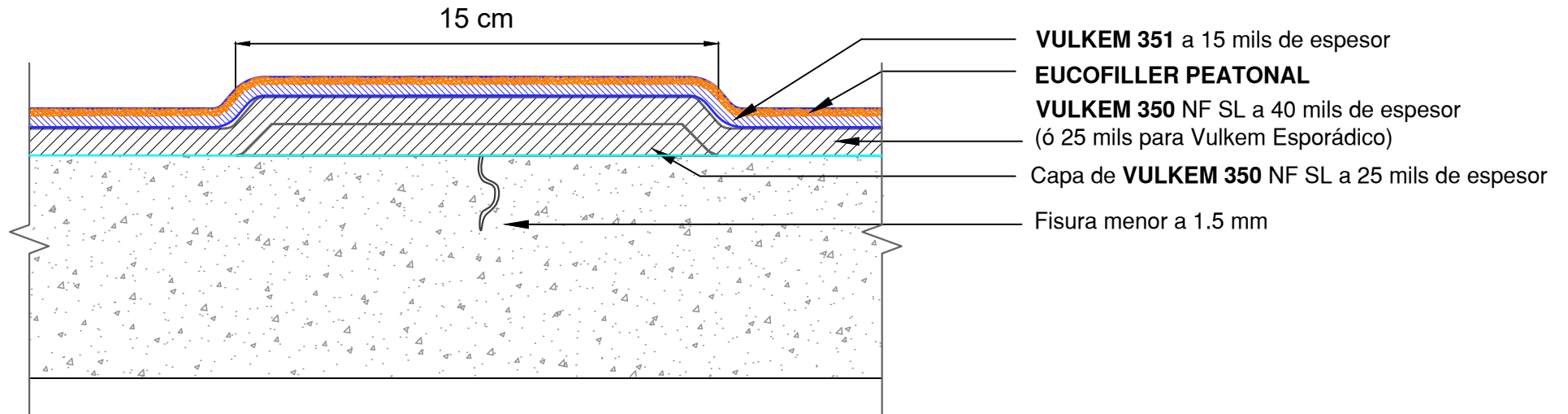



EUCLID CHEMICAL  
TOXEMENT

Detalle  
D4

Contiene  
IMPERMEABILIZACIÓN DE PLACAS Y CUBIERTAS  
TRATAMIENTO EN CAMBIOS DE NIVEL

Sistema  
VULKEM PEATONAL (350NF/351) Y ESPORÁDICO

Línea  
IMPERMEABILIZACIÓN DE PLACAS Y CUBIERTAS

Fecha  
09/11/2024

Versión  
V\_01

Convenciones



Eucofiller Peatonal



Vulkem 351



Vulkem 350 NF



Vulkem 171 Primer



Dymonic 100/Vulkem 116







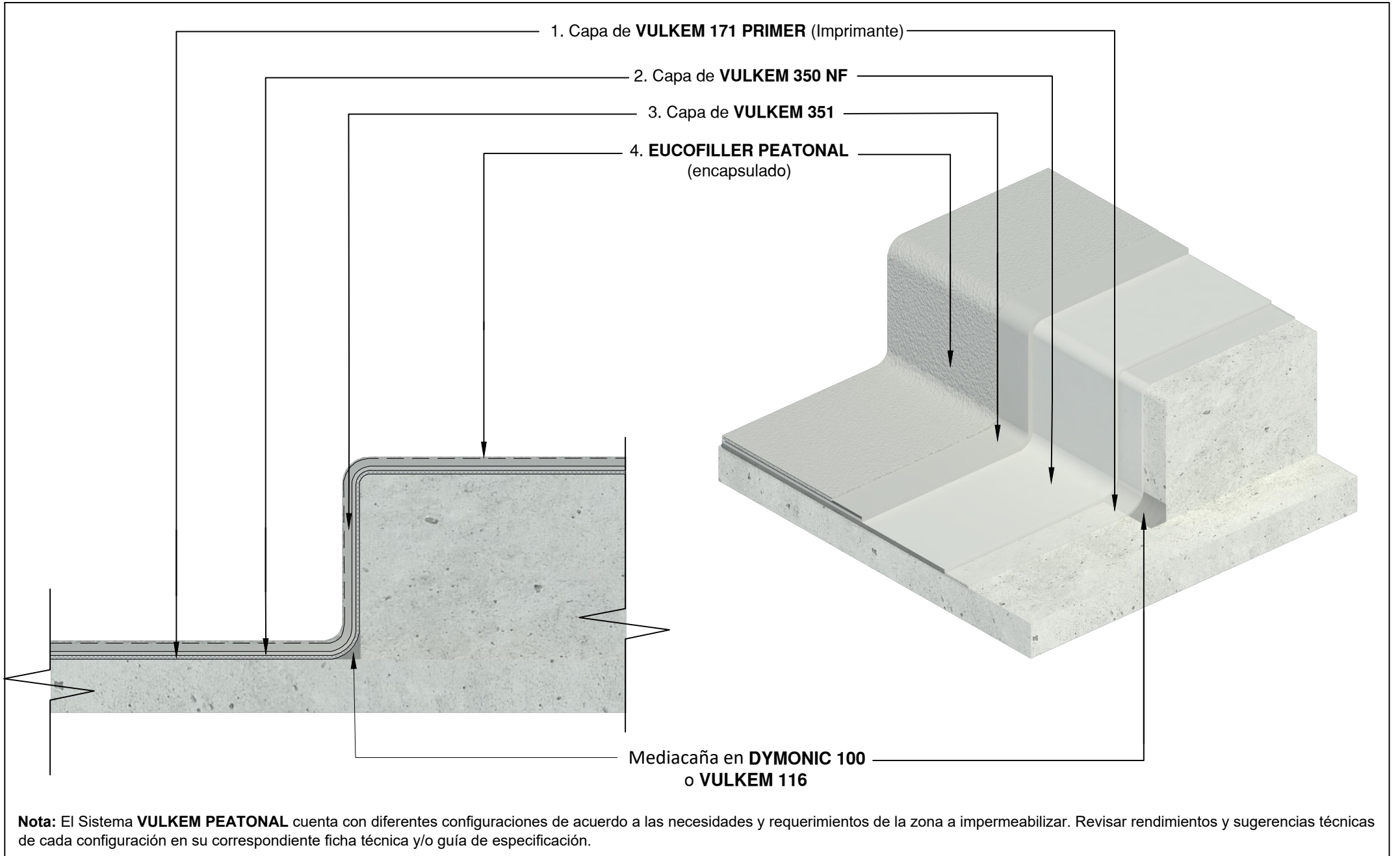

Estructura en concreto

Escala  
Sin escala







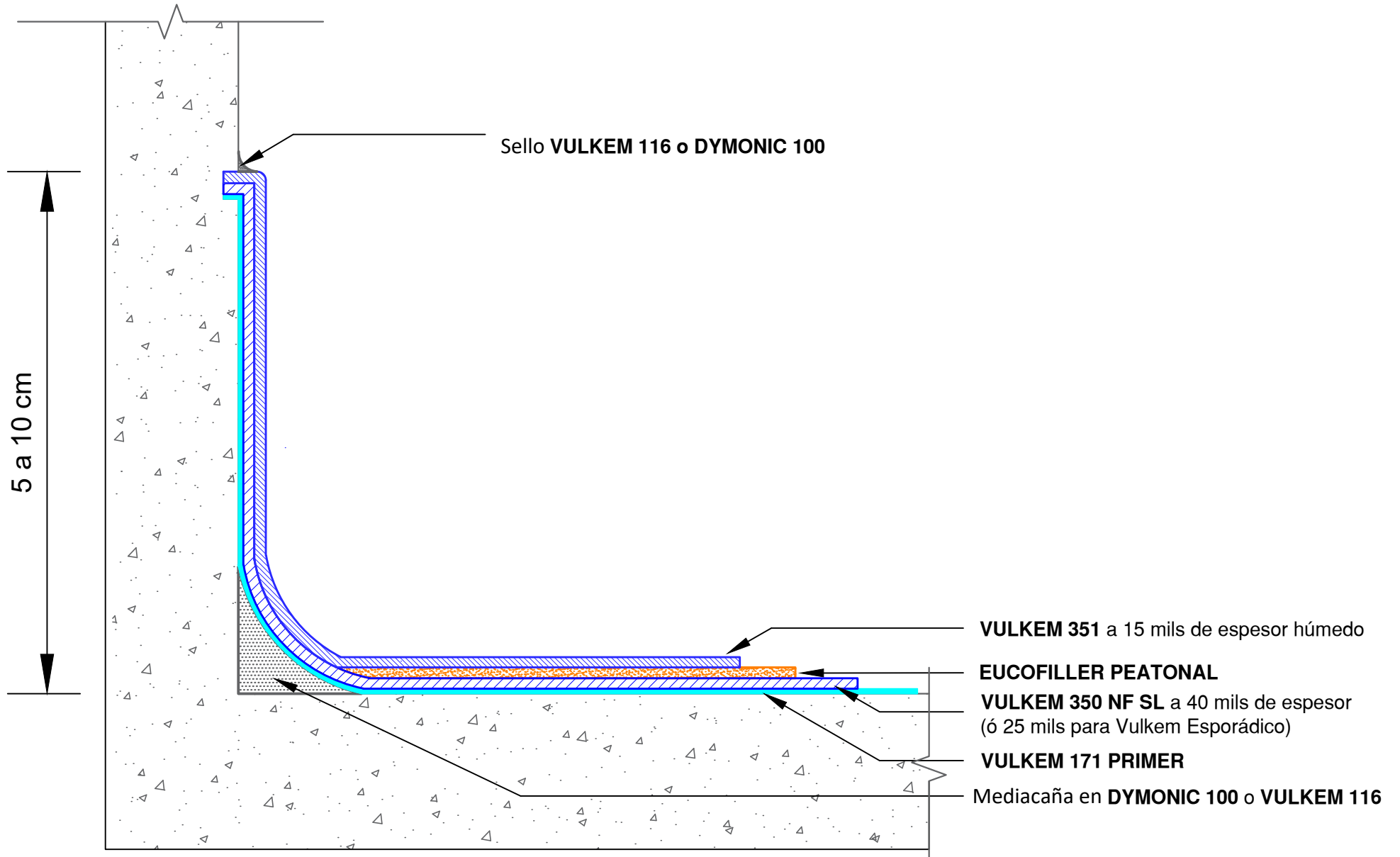

**EUCLID GROUP  
TOXEMENT**

Detalle D1/VP_Imp.PU	Contiene VULKEM PEATONAL (350NF/351) Y ESPORÁDICO TRATAMIENTO DE MEDIAS CAÑAS	Sistema VULKEM PEATONAL (350NF/351) Y ESPORÁDICO	Línea IMPERMEABILIZACIÓN DE PLACAS Y CUBIERTAS	Fecha 09/05/22	Versión V_04		
Convenciones	 Vulkem 350 NF SL	 Vulkem 351	 Eucofiller peatonal	 Vulkem 171 Primer	 Dymonic 100/Vulkem 116	 Estructura en concreto	Escala Sin escala





**EUCLID CHEMICAL  
TOXEMENT**

Detalle D8	Contiene TRATAMIENTO DE SIFONES Y DESAGÜES 1	Sistema VULKEM PEATONAL (350NF/351) Y ESPORÁDICO	Línea IMPERMEABILIZACIÓN DE PLACAS Y CUBIERTAS	Fecha 09/11/2024	Versión V_03	
Convenciones	 Sistema VULKEM	 Imprimante Vulkem 171 Primer	 Sello Dymonic 100/Vulkem 116	 Cordón de polietileno Sellasil Soporte	 Estructura en concreto	Escala Sin escala

Sello VULKEM 116, DYMONIC 100  
o VULKEM 45 SSL

Sistema VULKEM (VULKEM 350 NF +  
VULKEM 351 + EUCOFILLER PEATONAL)

Imprimante  
VULKEM 171 PRIMER



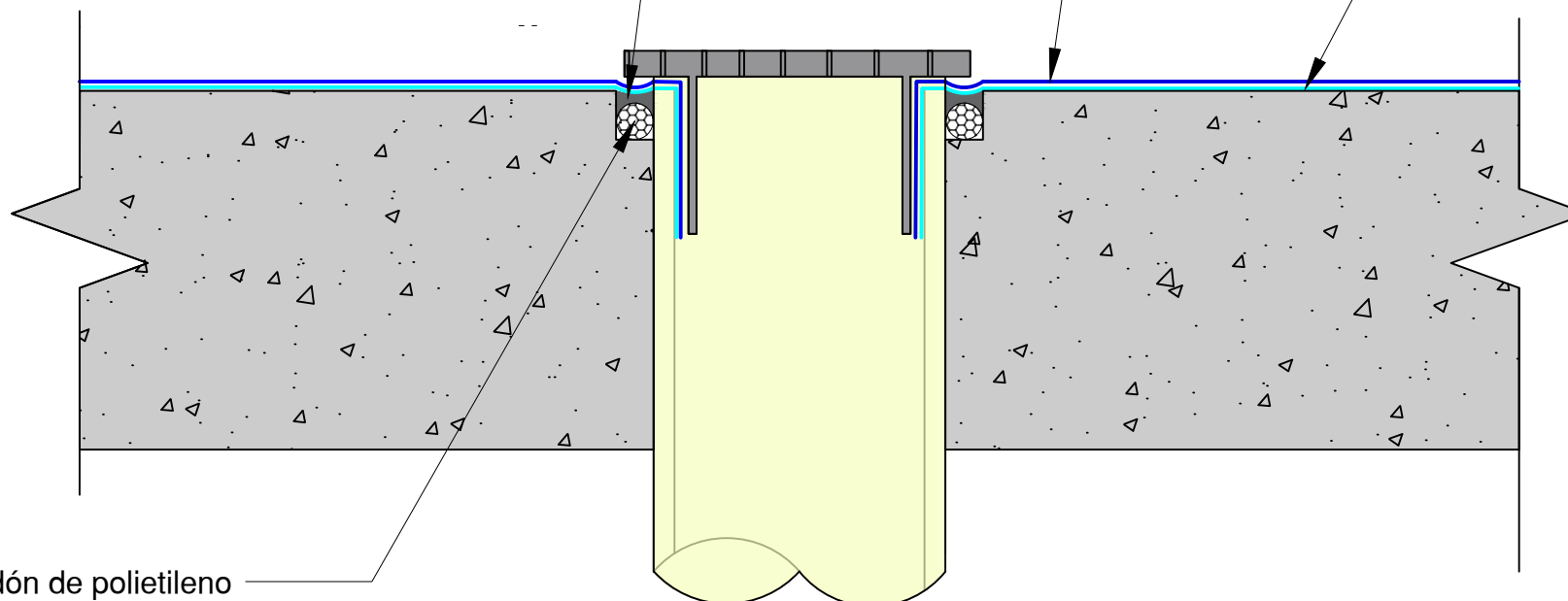

Cordón de polietileno  
SELLASIL SOPORTE



**TRATAMIENTO DE SIFONES Y DESAGÜES**



**EUCLID CHEMICAL  
TOXEMENT**

Detalle D8	Contiene TRATAMIENTO DE TUBOS SALIENTES	Sistema VULKEM PEATONAL (350NF/351) Y ESPORÁDICO	Línea IMPERMEABILIZACIÓN DE PLACAS Y CUBIERTAS	Fecha 09/11/2024	Versión V_03	
Convenciones	 Sistema VULKEM	 Imprimante Vulkem 171 Primer	 Sello Dymonic 100/Vulkem 116	 Cordón de polietileno Sellasil Soporte	 Estructura en concreto	Escala Sin escala

Imprimir con **TREMPRIME  
NON-POROUS PRIMER**

Mediacaña en **DYMONIC 100 o  
VULKEM 116**

Sistema **VULKEM (VULKEM 350 NF +  
VULKEM 351 + EUCOFILLER  
PEATONAL)**

**VULKEM 171 PRIMER**

